

HT10-4(4V10Ah)

HT Series General Battery

Spaceflight HT Series VRLA batteries are designed with AGM technology, high performance plates and technology to give extra power output for common power backup system. HT series batteries are the general purpose with 5-8 years floating design life at 25°C

Applications

- Uninterruptible Power Supply (UPS)
- Emergency backup power supply
- Auto control system
- Communication power supply
- Alarm and security system
- Electric Power System (EPS)

General Features

- 5-8 years design life(25°C)
- Non-spillable construction
- Sealed and maintenance-free
- High reliability and stability
- High purity raw material: long life and low self-discharge

Standards

- Compliance with IEC, BS, JIS and EU standards.
- UL, CE Certified
- ISO45001,ISO9001 and ISO14001 certified production facilities

Specifications

Rated Voltage	4V	
Nominal Capacity	10Ah	(C ₂₀ ,3.5V)
Approx Weight	0.95kg±3%(2.09lbs)	
Terminal	F1	
Rated Capacity(25°C)	10 Ah	(20hr,0.5A,3.5V)
	9.2 Ah	(10hr,0.92A,3.5V)
	8.0 Ah	(5hr,1.6A,3.5V)
	6.2 Ah	(1hr,6.2A,3.2V)
Max.Discharge Current	150A(5s)	
Max.Charge Current	2.5A	
Internal Resistance(25°C)	Approx 10mΩ	
Operating Temp.Range	Discharge	-20~60°C(-4~140°F)
	Charge	-10~50°C(14~122°F)
	Storage	-20~60°C(-4~140°F)
Nominal operating temperature	25±5°C	
Charge Voltage	Cycle Use	Initial Charging Current less than 2.5A. Voltage 4.8V~5.0V at 25°C(77°F)Temp. Coefficient -30mV/°C
	Standby Use	Initial Charging Current less than 2.5A. Voltage 4.5V~4.6V at 25°C(77°F)Temp. Coefficient -20mV/°C
Temperature effects on capacity	40°C (104°F)	103%
	25°C (77°F)	100%
	0°C (32°F)	86%
	-15°C (5°F)	65%
Self Discharge(25°C)	Capacity after 3 months storage	91%
	Capacity after 6 months storage	82%
	Capacity after 12 months storage	65%



Dimensions

unit:mm

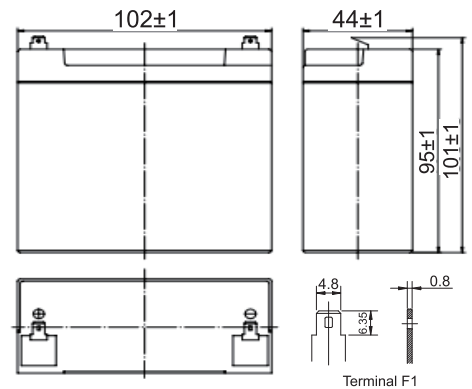

Length	102±2mm (4.02 inches)
Width	44±2mm (1.73 inches)
Container Height	95±2mm (3.74 inches)
Total Height	101±2mm (3.98 inches)

Battery Construction

Component	Positive plate	Negative plate	Container	Safety valve	Terminal	Separator	Electrolyte
Raw material	Lead dioxide	Lead	ABS(UL94-HB) or FR(UL94-V0)	Rubber	Copper	Fiberglass	Sulfuric acid

Constant Current Discharge (Amperes) at 25°C(77°F)

E.V/Time	5min	10min	15min	30min	60min	3h	5h	10h	20h
1.60V	36.10	26.60	18.65	11.00	6.20	2.52	1.67	0.94	0.523
1.65V	35.20	26.10	18.10	10.87	6.18	2.50	1.63	0.93	0.516
1.70V	34.20	25.20	17.54	10.39	6.14	2.40	1.61	0.93	0.510
1.75V	33.10	24.20	16.43	9.89	6.08	2.36	1.60	0.92	0.500
1.80V	32.40	23.30	15.43	9.38	6.01	2.34	1.48	0.90	0.482

Constant Power Discharge (Watts/cell) at 25°C(77°F)

E.V/Time	5min	10min	15min	30min	45min	60min	2h	3h	5h
1.60V	79.6	49.7	38.4	21.76	16.1	12.77	7.00	4.82	3.44
1.65V	75.8	49.2	37.9	21.2	15.76	12.43	6.92	4.76	3.37
1.70V	71.9	47.6	35.6	20.53	15.2	12.21	6.75	4.66	3.31
1.75V	68.2	45.6	34.6	19.54	14.32	11.88	6.59	4.53	3.24
1.80V	64.4	43.5	32.6	18.43	13.54	11.54	6.40	4.35	3.16

Note: The above characteristics data are average values obtained Within three charge/discharge cycles not the minimum.

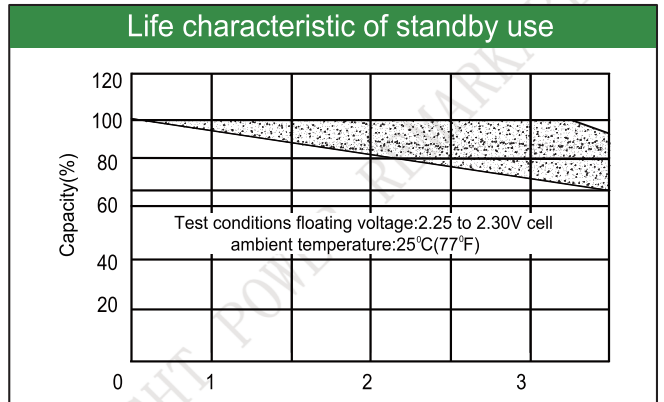
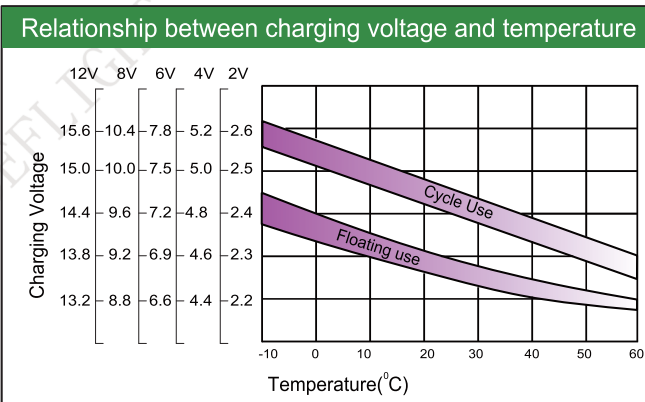
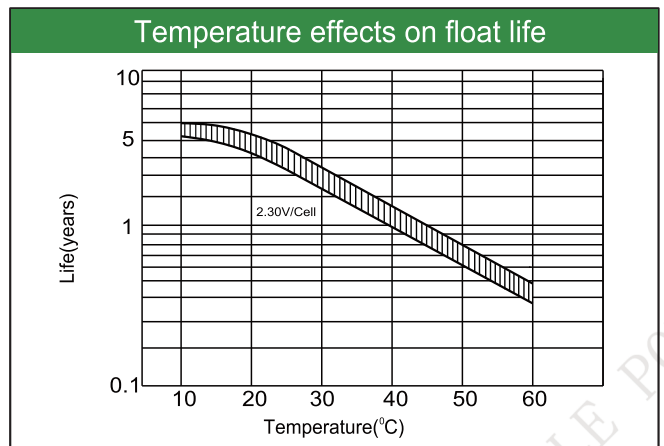
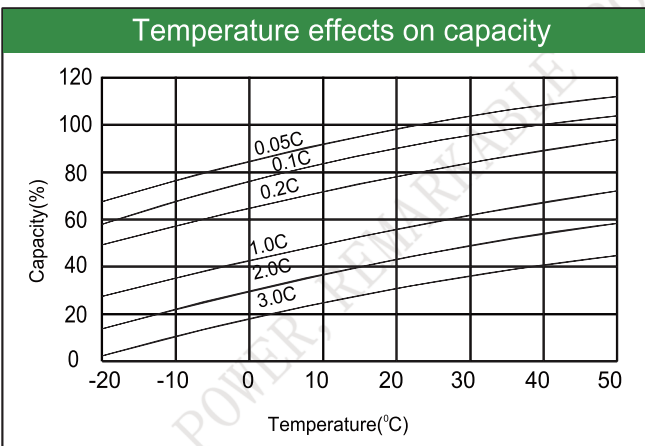
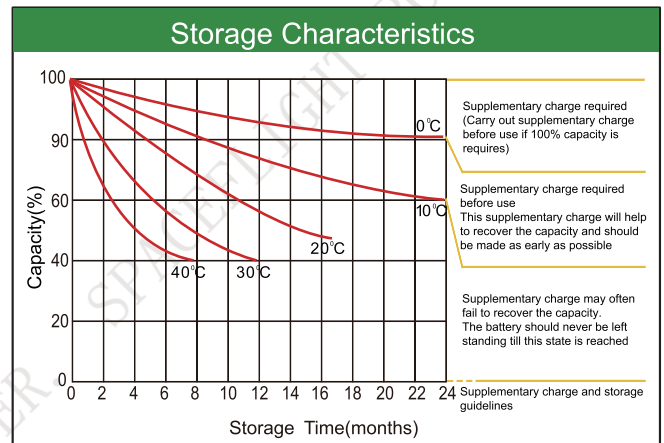
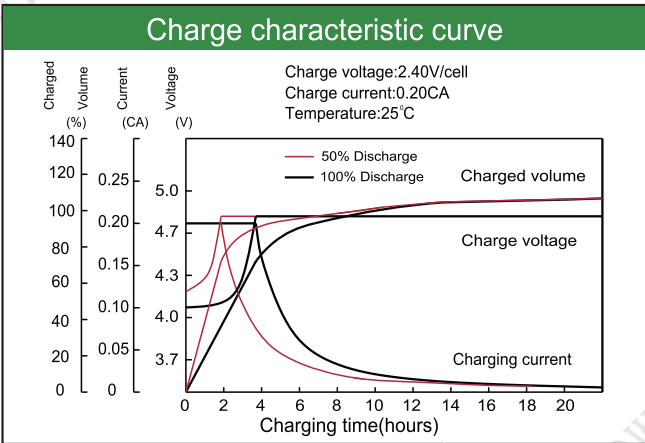
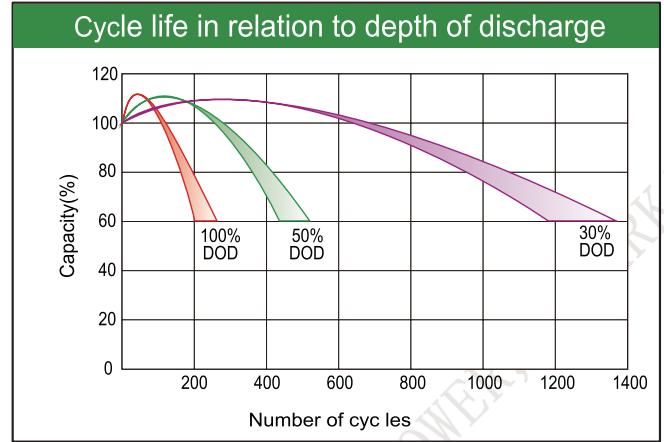
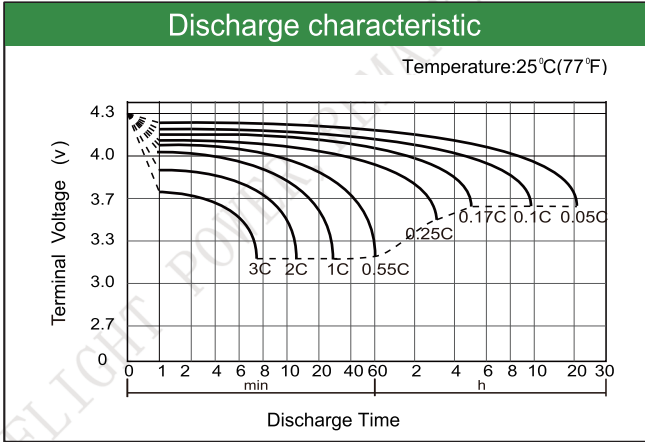

Factory address: Fukang Industrial Zone, Longnan, Ganzhou, Jiangxi Province, China.
 Shenzhen Office: RM208-210, Building D, Tongju industrial Park, No.4, Longping West Road, Longgang District, Shenzhen.
 TEL: +86-755-28288189 sales@sfbattery.com www.sfbattery.com