

### HT Series General Battery

Spaceflight HT Series VRLA batteries are designed with AGM technology, high performance plates and technology to give extra power output for common power backup system. HT series batteries are the general purpose with 5-8 years floating design life at 25°C

### Applications

- Uninterruptible Power Supply (UPS)
- Emergency backup power supply
- Auto control system
- Communication power supply
- Alarm and security system
- Electric Power System (EPS)

### General Features

- 10-12 years design life(25°C)
- Non-spillable construction
- Sealed and maintenance-free
- High reliability and stability
- High purity raw material: long life and low self-discharge

### Standards

- Compliance with IEC, BS, JIS and EU standards.
- UL, CE Certified
- ISO45001,ISO9001 and ISO14001 certified production facilities

### Specifications

Rated Voltage	12V	
Nominal Capacity	180Ah	(C <sub>10</sub> , 10.8V)
Approx Weight	55kg±3%(121.25lbs)	
Terminal	F12	
Rated Capacity(25°C)	186 Ah	(20hr,9.3A,10.5V)
	180 Ah	(10hr,18A,10.8V)
	160 Ah	(5hr,32A,10.5V)
	115 Ah	(1hr,115A,9.6V)
Max.Discharge Current	1800A(5s)	
Max.Charge Current	45A	
Internal Resistance(25°C)	Approx4.5mΩ	
Operating Temp.Range	Discharge	-20~60°C(-4~140°F)
	Charge	-10~50°C(14~122°F)
	Storage	-20~60°C(-4~140°F)
Nominal operating temperature	25±5°C	
Charge Voltage @25°C(77°F)	Cycle Use	Initial Charging Current less than 45A. Voltage 14.4V~15.0V at 25°C(77°F)Temp. Coefficient -30mV/°C
	Standby Use	Initial Charging Current less than 45A. Voltage 13.5V~13.8V at 25°C(77°F)Temp. Coefficient -20mV/°C
Temperature effects on capacity	40°C (104°F)	103%
	25°C (77°F)	100%
	0°C (32°F)	86%
	-15°C (5°F)	65%
Self Discharge(25°C)	Capacity after 3 months storage	91%
	Capacity after 6 months storage	82%
	Capacity after 12 months storage	65%



### Dimensions

unit:mm

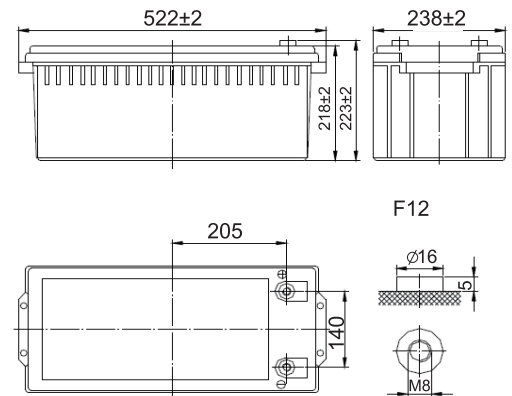

Length	522±2mm (20.6 inches)
Width	238±2mm (9.37 inches)
Container Height	218±2mm (8.58 inches)
Total Height	223±2mm (8.78 inches)

### Battery Construction

Component	Positive plate	Negative plate	Container	Safety valve	Terminal	Separator	Electrolyte
Raw material	Lead dioxide	Lead	ABS(UL94-HB) or FR(UL94-V0)	Rubber	Copper	Fiberglass	Sulfuric acid

### Constant Current Discharge (Amperes) at 25°C(77°F)

E.V/Time	5min	10min	15min	30min	1h	3h	5h	10h	20h
1.60V	/	395	315	195	115	48.5	33.5	18.30	9.55
1.65V	/	372	295	188	113	47.8	33.0	18.20	9.50
1.70V	/	349	275	181	111	47.0	32.5	18.20	9.45
1.75V	/	325	253	178	109	46.2	32.0	18.10	9.30
1.80V	/	300	230	170	106	45.2	31.4	18.00	9.25

### Constant Power Discharge (Watts/cell) at 25°C(77°F)

E.V/Time	5min	10min	15min	30min	45min	1h	2h	3h	5h
1.60V	/	630	510	337	241	223	123	87.7	60.5
1.65V	/	605	492	324	236	219	121	86.5	60.2
1.70V	/	579	477	312	231	214	118	85.3	59.7
1.75V	/	550	461	299	227	210	115	84.1	59.4
1.80V	/	520	425	282	222	205	117	83.2	58.7

Note: The above characteristics data are average values obtained Within three charge/discharge cycles not the minimum.

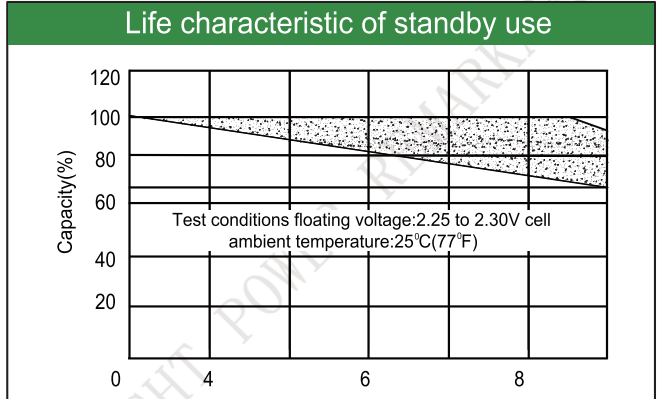
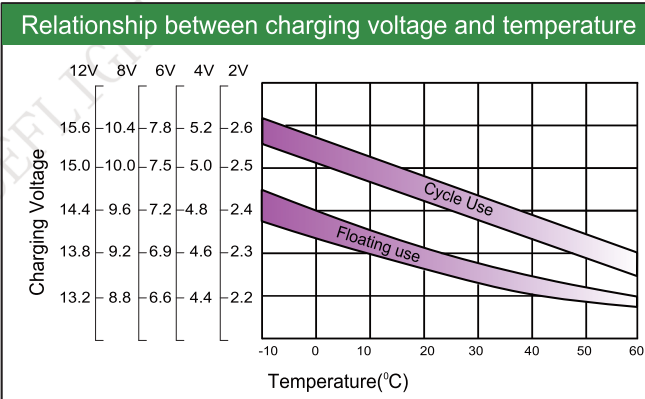
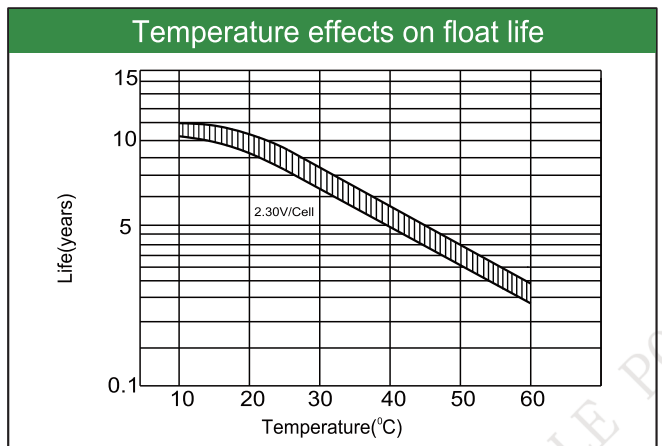
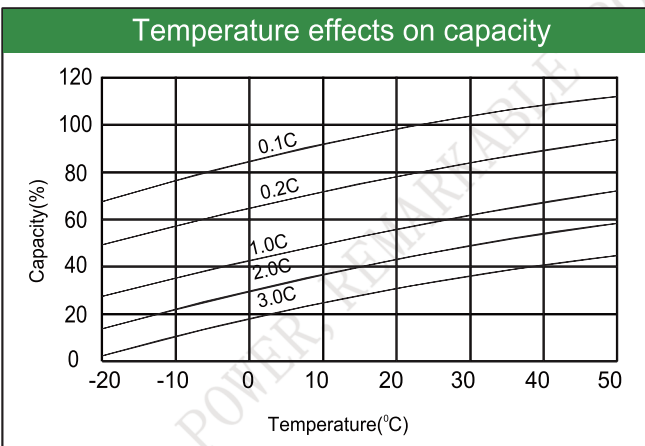
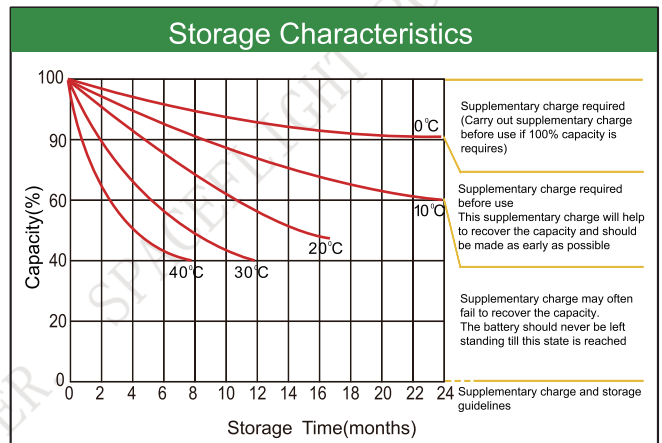
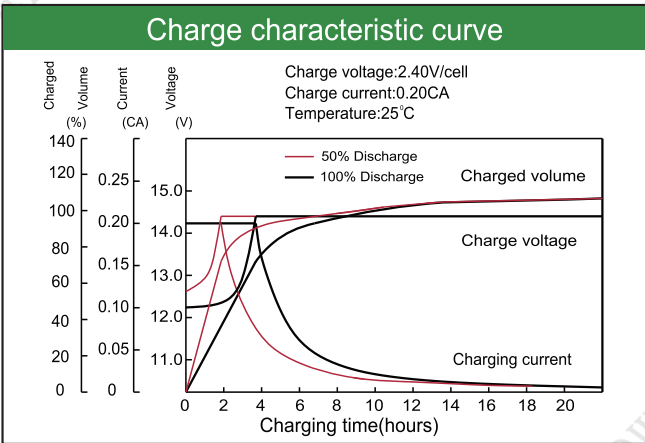
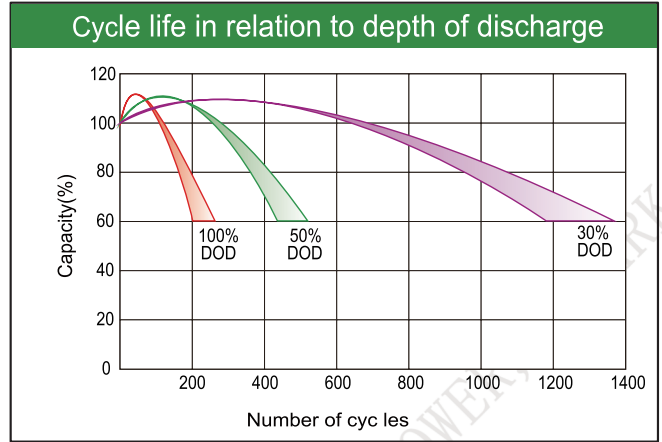
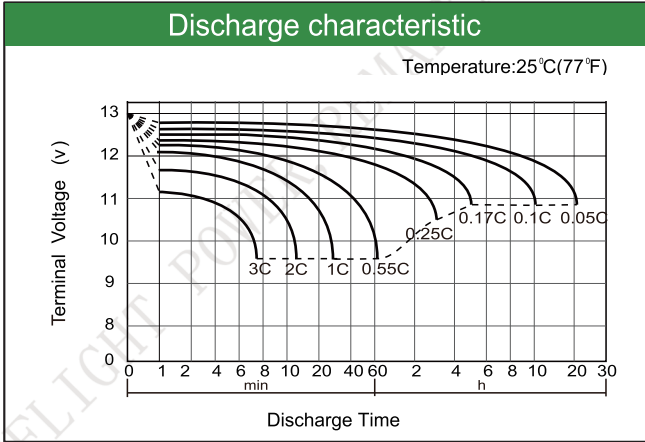

Factory address: Fukang Industrial Zone, Longnan, Ganzhou, Jiangxi Province, China.  
 Shenzhen Office: RM208-210, Building D, Tongju industrial Park, No.4, Longping West Road, Longgang District, Shenzhen.  
 TEL: +86-755-28288189      [sales@sfbattery.com](mailto:sales@sfbattery.com)      [www.sfbattery.com](http://www.sfbattery.com)