

HT Series General Battery

Spaceflight HT Series VRLA batteries are designed with AGM technology, high performance plates and technology to give extra power output for common power backup system. HT series batteries are the general purpose with 5-8 years floating design life at 25°C

Applications

- Uninterruptible Power Supply (UPS)
- Emergency backup power supply
- Auto control system
- Communication power supply
- Alarm and security system
- Electric Power System (EPS)

General Features

- 5-8 years design life(25°C)
- Non-spillable construction
- Sealed and maintenance-free
- High reliability and stability
- High purity raw material: long life and low self-discharge

Standards

- Compliance with IEC, BS, JIS and EU standards.
- UL, CE Certified
- ISO45001,ISO9001 and ISO14001 certified production facilities

Specifications

| | | |
|---------------------------------|----------------------------------|---|
| Rated Voltage | 12V | |
| Nominal Capacity | 2.6Ah | (C ₂₀ , 10.5V) |
| Approx Weight | 0.75kg±3%(1.65lbs) | |
| Terminal | F1 | |
| Rated Capacity(25°C) | 2.6 Ah | (20hr,0.13A,10.5V) |
| | 2.3 Ah | (10hr,0.23A,10.5V) |
| | 2.15 Ah | (5hr,0.43A,10.5V) |
| | 1.56 Ah | (1hr,1.56A,9.6V) |
| Max.Discharge Current | 39A(5s) | |
| Max.Charge Current | 0.65A | |
| Internal Resistance(25°C) | Approx60 mΩ | |
| Operating Temp.Range | Discharge | -20~60°C(-4~140°F) |
| | Charge | -10~50°C(14~122°F) |
| | Storage | -20~60°C(-4~140°F) |
| Nominal operating temperature | 25±5°C | |
| Charge Voltage @25°C(77°F) | Cycle Use | Initial Charging Current less than 0.65A. Voltage 14.4V~15.0V at 25°C(77°F)Temp. Coefficient -30mV/°C |
| | Standby Use | Initial Charging Current less than 0.65A. Voltage 13.5V~13.8V at 25°C(77°F)Temp. Coefficient -20mV/°C |
| Temperature effects on capacity | 40°C (104°F) | 103% |
| | 25°C (77°F) | 100% |
| | 0°C (32°F) | 86% |
| | -15°C (5°F) | 65% |
| Self Discharge(25°C) | Capacity after 3 months storage | 91% |
| | Capacity after 6 months storage | 82% |
| | Capacity after 12 months storage | 65% |



Dimensions

unit:mm

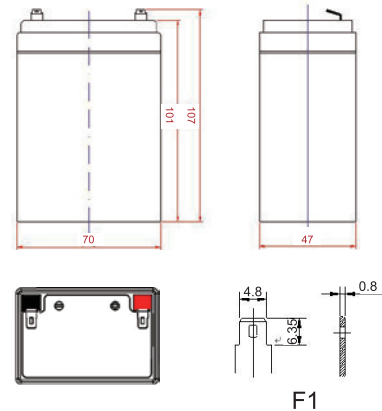

| | |
|------------------|-----------------------|
| Length | 70±2mm (2.76 inches) |
| Width | 47±2mm (1.85 inches) |
| Container Height | 101±2mm (3.98 inches) |
| Total Height | 107±2mm (4.21 inches) |

Battery Construction

| Component | Positive plate | Negative plate | Container | Safety valve | Terminal | Separator | Electrolyte |
|--------------|----------------|----------------|-----------------------------|--------------|----------|------------|---------------|
| Raw material | Lead dioxide | Lead | ABS(UL94-HB) or FR(UL94-V0) | Rubber | Copper | Fiberglass | Sulfuric acid |

Constant Current Discharge (Amperes) at 25°C(77°F)

| E.V/Time | 5min | 10min | 15min | 30min | 60min | 3h | 5h | 10h | 20h |
|----------|------|-------|-------|-------|-------|------|------|------|-------|
| 1.60V | 8.75 | 5.40 | 4.40 | 2.56 | 1.56 | 0.69 | 0.45 | 0.25 | 0.133 |
| 1.65V | 8.25 | 5.09 | 4.18 | 2.45 | 1.51 | 0.66 | 0.44 | 0.24 | 0.132 |
| 1.70V | 7.75 | 4.82 | 3.99 | 2.34 | 1.45 | 0.63 | 0.44 | 0.24 | 0.130 |
| 1.75V | 7.25 | 4.56 | 3.79 | 2.23 | 1.41 | 0.62 | 0.43 | 0.23 | 0.130 |
| 1.80V | 6.82 | 4.35 | 3.59 | 2.12 | 1.34 | 0.59 | 0.41 | 0.21 | 0.125 |

Constant Power Discharge (Watts/cell) at 25°C(77°F)

| E.V/Time | 5min | 10min | 15min | 30min | 45min | 60min | 2h | 3h | 5h |
|----------|------|-------|-------|-------|-------|-------|------|------|------|
| 1.60V | 16.8 | 10.4 | 8.32 | 5.21 | 3.75 | 3.02 | 1.87 | 1.16 | 0.76 |
| 1.65V | 15.6 | 9.81 | 7.87 | 4.95 | 3.58 | 2.89 | 1.81 | 1.14 | 0.75 |
| 1.70V | 14.6 | 9.18 | 7.44 | 4.68 | 3.40 | 2.75 | 1.75 | 1.11 | 0.73 |
| 1.75V | 13.6 | 8.60 | 7.00 | 4.41 | 3.21 | 2.62 | 1.68 | 1.07 | 0.72 |
| 1.80V | 12.6 | 8.08 | 6.50 | 4.14 | 3.03 | 2.48 | 1.62 | 1.04 | 0.70 |

Note: The above characteristics data are average values obtained Within three charge/discharge cycles not the minimum.

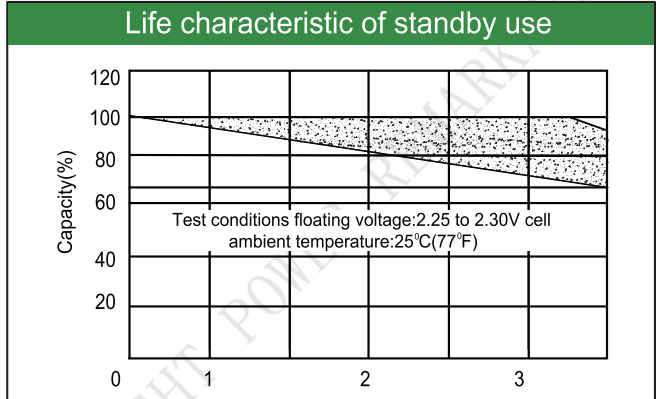
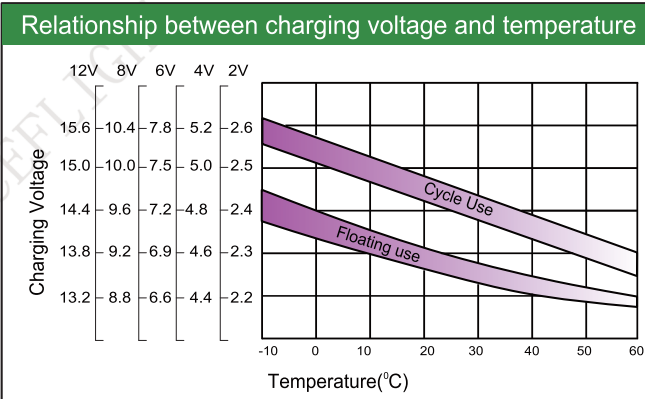
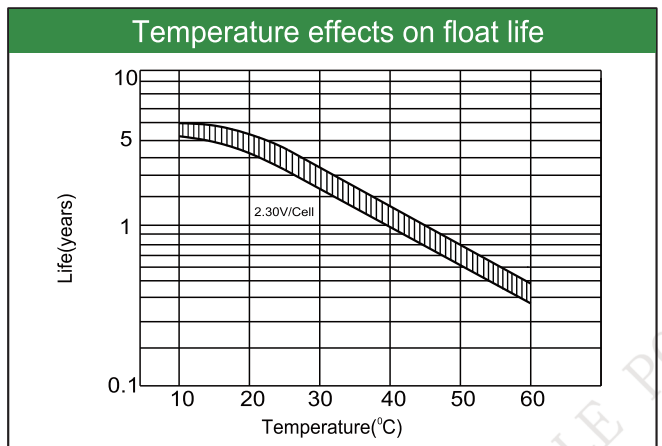
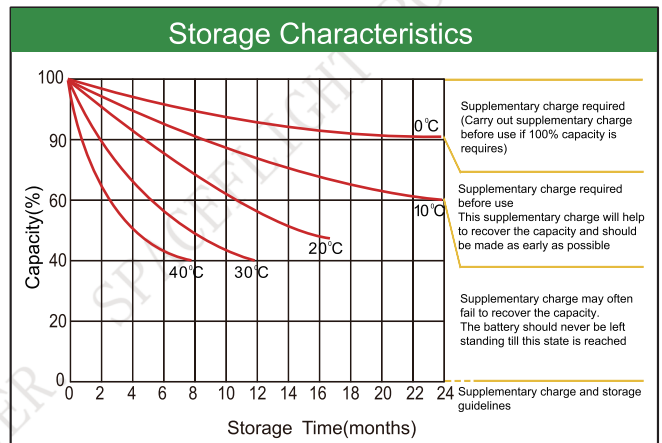
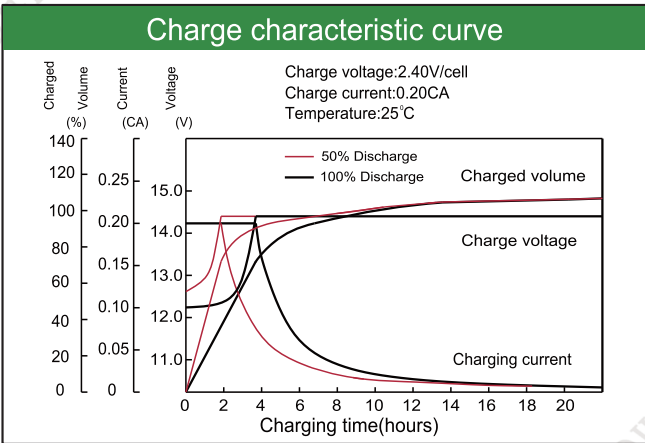
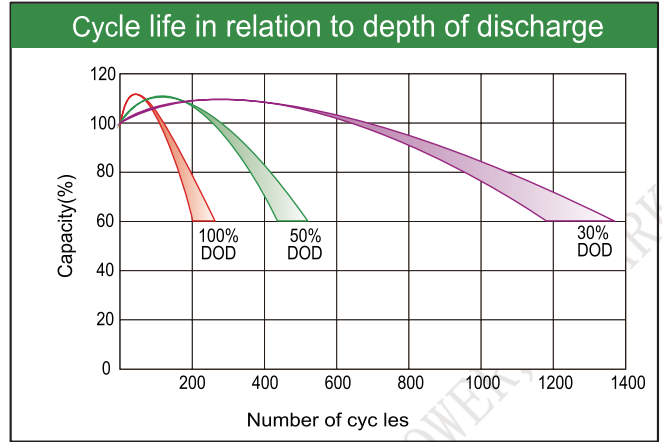
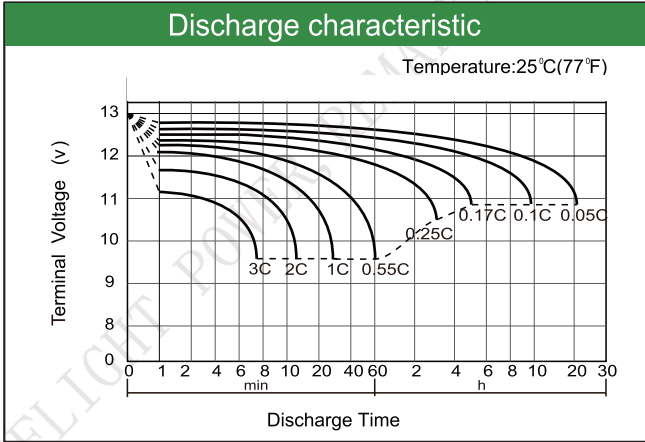

Factory address: Fukang Industrial Zone, Longnan, Ganzhou, Jiangxi Province, China.
Shenzhen Office: RM208-210, Building D, Tongju industrial Park, No.4, Longping West Road, Longgang District, Shenzhen.
TEL: +86-755-28288189 sales@sfbattery.com www.sfbattery.com