

HT Series General Battery

Spaceflight HT Series VRLA batteries are designed with AGM technology, high performance plates and technology to give extra power output for common power backup system. HT series batteries are the general purpose with 5-8 years floating design life at 25°C

Applications

- Uninterruptible Power Supply (UPS)
- Emergency backup power supply
- Auto control system
- Communication power supply
- Alarm and security system
- Electric Power System (EPS)

General Features

- 10-12 years design life(25°C)
- Non-spillable construction
- Sealed and maintenance-free
- High reliability and stability
- High purity raw material: long life and low self-discharge

Standards

- Compliance with IEC, BS, JIS and EU standards.
- UL, CE Certified
- ISO45001,ISO9001 and ISO14001 certified production facilities

Specifications

Rated Voltage	12V	
Nominal Capacity	200Ah	(C ₁₀ , 10.8V)
Approx Weight	57.5kg±3%(126.7lbs)	
Terminal	F12/F16	
Rated Capacity(25°C)	206 Ah	(20hr, 10.3A, 10.5V)
	200 Ah	(10hr, 20A, 10.8V)
	175 Ah	(5hr, 35.0A, 10.5V)
	128 Ah	(1hr, 128A, 9.6V)
Max. Discharge Current	2000A(5s)	
Max. Charge Current	50A	
Internal Resistance(25°C)	Approx 4.5mΩ	
Operating Temp. Range	Discharge	-20~60°C (-4~140°F)
	Charge	-10~50°C (14~122°F)
	Storage	-20~60°C (-4~140°F)
Nominal operating temperature	25±5°C	
Charge Voltage	Cycle Use	Initial Charging Current less than 50A. Voltage 14.4V~15.0V at 25°C(77°F)Temp. Coefficient -30mV/°C
	Standby Use	Initial Charging Current less than 50A. Voltage 13.5V~13.8V at 25°C(77°F)Temp. Coefficient -20mV/°C
Temperature effects on capacity	40°C (104°F)	103%
	25°C (77°F)	100%
	0°C (32°F)	86%
	-15°C (5°F)	65%
Self Discharge(25°C)	Capacity after 3 months storage	91%
	Capacity after 6 months storage	82%
	Capacity after 12 months storage	65%



Dimensions

unit:mm

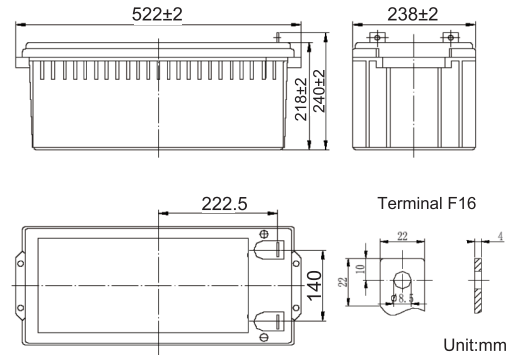

Length	522±2mm (20.6 inches)
Width	238±2mm (9.37 inches)
Container Height	218±2mm (8.58 inches)
Total Height	240±2mm (9.45 inches)

Battery Construction

Component	Positive plate	Negative plate	Container	Safety valve	Terminal	Separator	Electrolyte
Raw material	Lead dioxide	Lead	ABS(UL94-HB) or FR(UL94-V0)	Rubber	Copper	Fiberglass	Sulfuric acid

Constant Current Discharge (Amperes) at 25°C(77°F)

E.V/Time	5min	10min	15min	30min	1h	3h	5h	10h	20h
1.60V	/	405	335	205	128	54.2	37.5	20.4	10.5
1.65V	/	389	323	199	126	53.2	36.6	20.3	10.4
1.70V	/	372	310	192	123	52.0	35.8	20.2	10.4
1.75V	/	353	296	185	120	50.8	35.0	20.1	10.3
1.80V	/	332	280	177	116	49.5	34.1	20.0	10.2

Constant Power Discharge (Watts/cell) at 25°C(77°F)

E.V/Time	5min	10min	15min	30min	45min	1h	2h	3h	5h
1.60V	/	695	590	375	280	235	140.0	103.3	72.0
1.65V	/	670	570	374	272	230	137.5	101.6	71.1
1.70V	/	643	548	362	263	225	134.5	99.6	70.0
1.75V	/	614	524	349	254	219	131.0	97.3	68.7
1.80V	/	583	498	334	244	212	127.2	94.5	67.2

Note: The above characteristics data are average values obtained Within three charge/discharge cycles not the minimum.

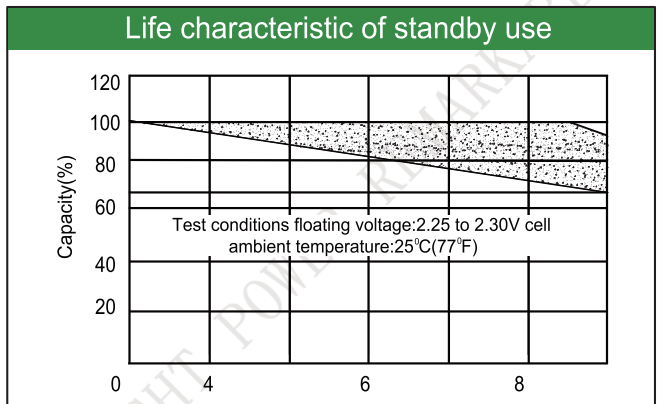
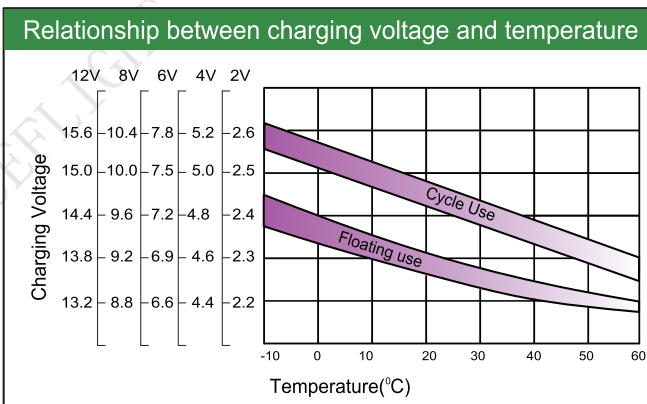
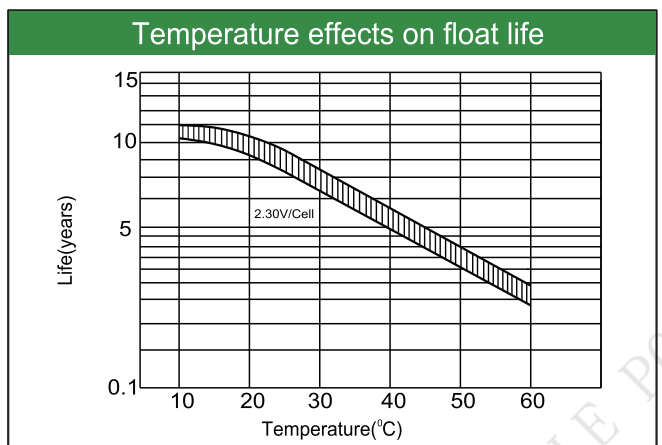
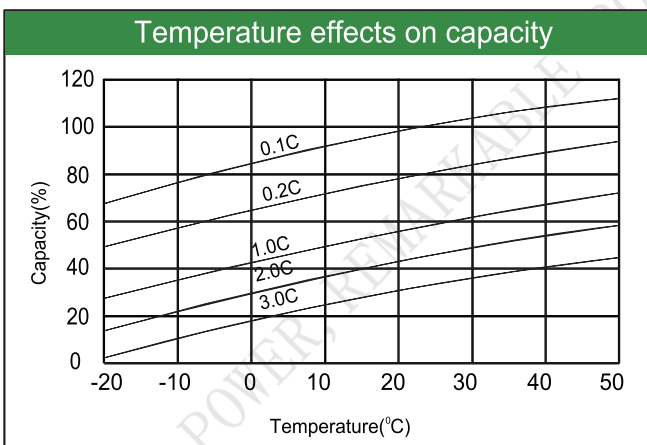
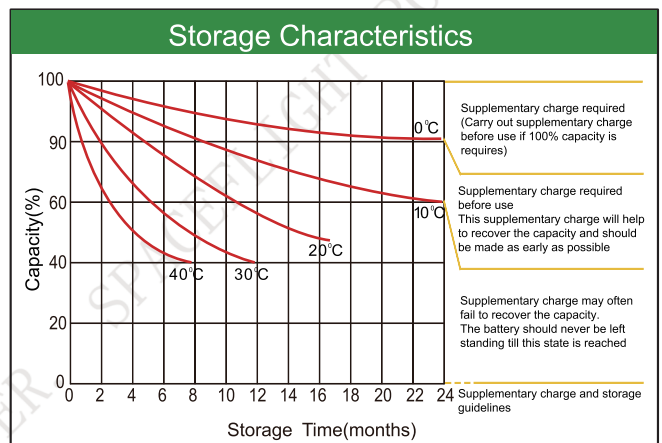
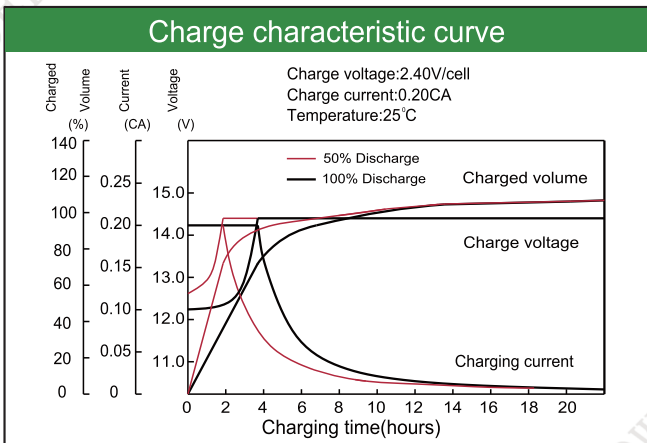
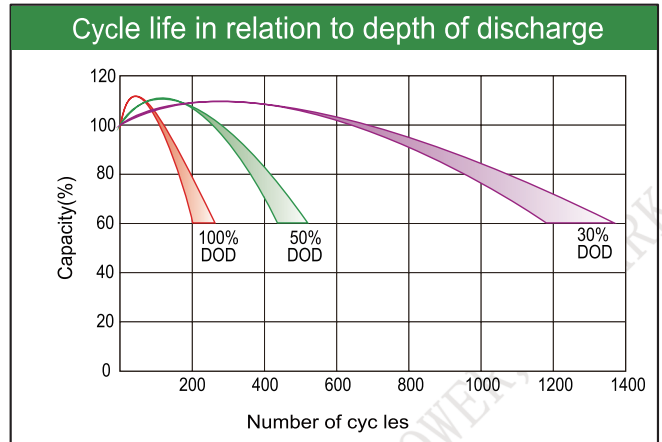
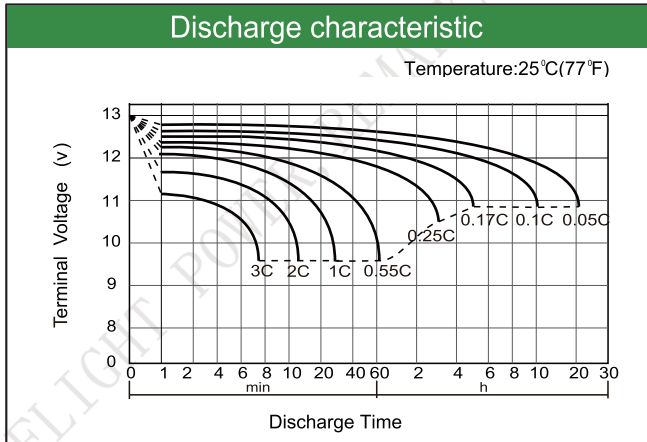

Factory address: Fukang Industrial Zone, Longnan, Ganzhou, Jiangxi Province, China.
 Shenzhen Office: RM208-210, Building D, Tongju industrial Park, No.4, Longping West Road, Longgang District, Shenzhen.
 TEL: +86-755-28288189 sales@sfbattery.com www.sfbattery.com