

HT Series General Battery

Spaceflight HT Series VRLA batteries are designed with AGM technology, high performance plates and technology to give extra power output for common power backup system. HT series batteries are the general purpose with 5-8 years floating design life at 25°C

Applications

- Uninterruptible Power Supply (UPS)
- Emergency backup power supply
- Auto control system
- Communication power supply
- Alarm and security system
- Electric Power System (EPS)

General Features

- 10-12 years design life(25°C)
- Non-spillable construction
- Sealed and maintenance-free
- High reliability and stability
- High purity raw material: long life and low self-discharge

Standards

- Compliance with IEC, BS, JIS and EU standards.
- UL, CE Certified
- ISO45001,ISO9001 and ISO14001 certified production facilities

Specifications

Rated Voltage	12V	
Nominal Capacity	220Ah	(C ₁₀ , 10.8V)
Approx Weight	62.0kg±3%(136.6lbs)	
Terminal	F12/F16	
Rated Capacity(25°C)	220 Ah	(10hr,22A,10.8V)
	188 Ah	(5hr,37.6A,10.5V)
	176.7 Ah	(3hr,58.9A,10.2V)
	158 Ah	(1hr,158A,9.6V)
Max.Discharge Current	2200A(5s)	
Max.Charge Current	55A	
Internal Resistance(25°C)	Approx2.8mΩ	
Operating Temp.Range	Discharge	-20~60°C(-4~140°F)
	Charge	-10~50°C(14~122°F)
	Storage	-20~60°C(-4~140°F)
Nominal operating temperature	25±5°C	
Charge Voltage	Cycle Use	Initial Charging Current less than 55A. Voltage 14.4V~15.0V at 25°C(77°F)Temp. Coefficient -30mV/°C
	Standby Use	Initial Charging Current less than 55A. Voltage 13.5V~13.8V at 25°C(77°F)Temp. Coefficient -20mV/°C
Temperature effects on capacity	40°C (104°F)	103%
	25°C (77°F)	100%
	0°C (32°F)	86%
	-15°C (5°F)	65%
Self Discharge(25°C)	Capacity after 3 months storage	91%
	Capacity after 6 months storage	82%
	Capacity after 12 months storage	65%



Dimensions unit:mm

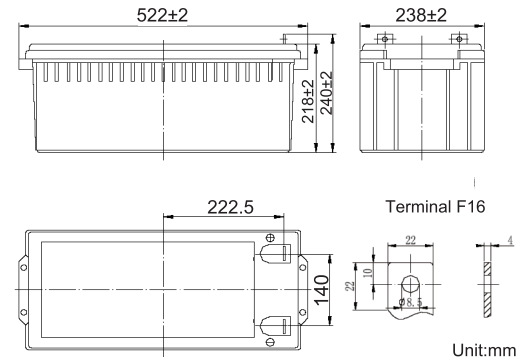

Length	522±2mm (20.6 inches)
Width	238±2mm (9.37 inches)
Container Height	218±2mm (8.58 inches)
Total Height	240±2mm (9.45 inches)

Battery Construction

Component	Positive plate	Negative plate	Container	Safety valve	Terminal	Separator	Electrolyte
Raw material	Lead dioxide	Lead	ABS(UL94-HB) or FR(UL94-V0)	Rubber	Copper	Fiberglass	Sulfuric acid

Constant Current Discharge (Amperes) at 25°C(77°F)

E.V/Time	5min	10min	15min	30min	1h	3h	5h	10h	20h
1.60V	/	480.0	390.0	250.0	158.0	61.0	39.6	22.4	11.50
1.65V	/	456.0	372.0	240.0	155.0	60.0	39.0	22.4	11.50
1.70V	/	430.0	352.0	228.0	151.0	58.9	38.3	22.3	11.40
1.75V	/	404.0	332.0	215.0	147.0	57.7	37.6	22.2	11.40
1.80V	/	376.0	310.0	201.0	142.0	56.5	36.8	22.0	11.30

Constant Power Discharge (Watts/cell) at 25°C(77°F)

E.V/Time	5min	10min	15min	30min	45min	1h	2h	3h	5h
1.60V	/	857.0	730.0	475.0	350.0	278.0	164	118	77.80
1.65V	/	832.0	710.0	462.0	340.0	272.0	161	116	76.30
1.70V	/	802.0	688.0	448.0	330.0	265.0	157	113	74.50
1.75V	/	770.0	665.0	433.0	319.0	257.0	152	110	72.50
1.80V	/	735.0	640.0	416.0	307.0	248.0	146	107	70.30

Note: The above characteristics data are average values obtained Within three charge/discharge cycles not the minimum.

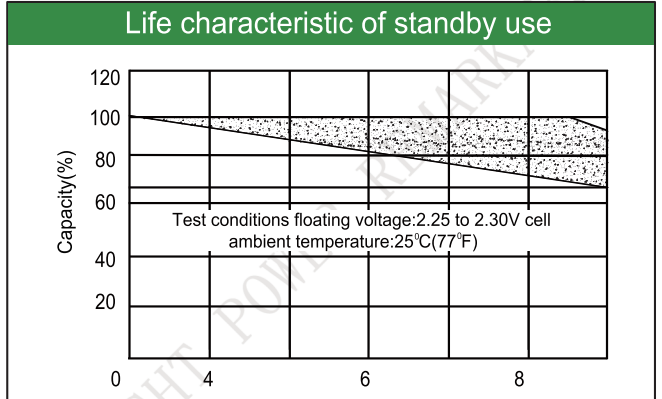
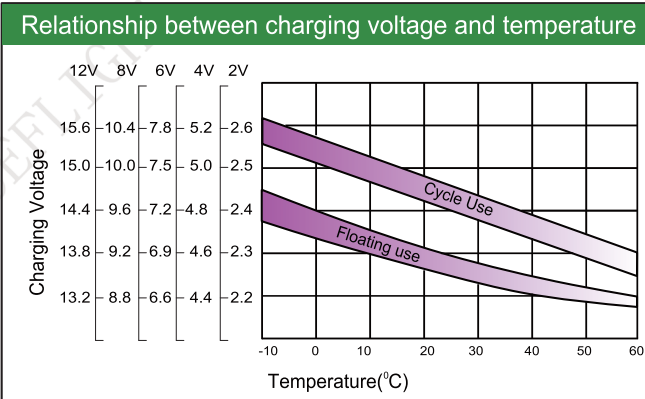
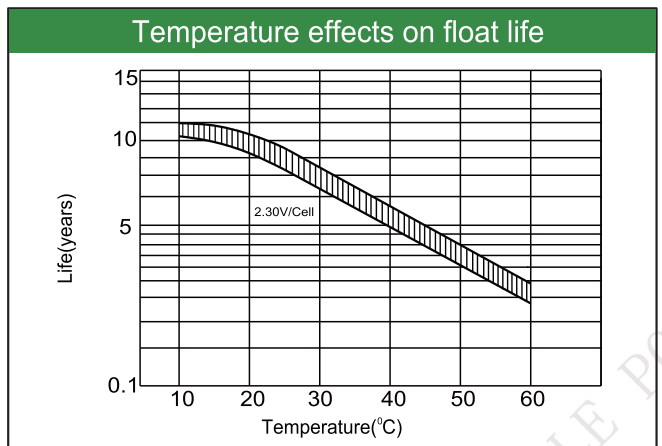
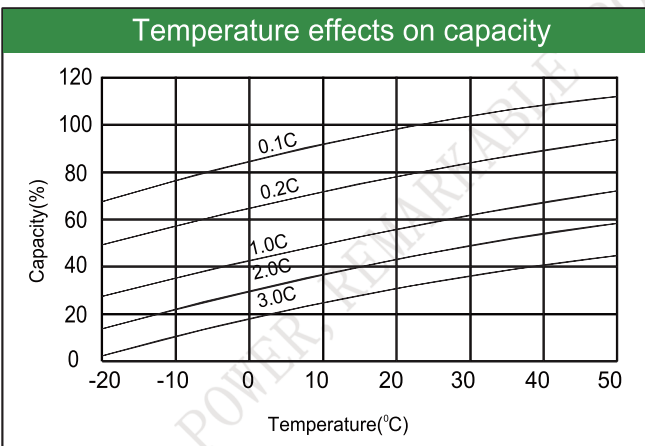
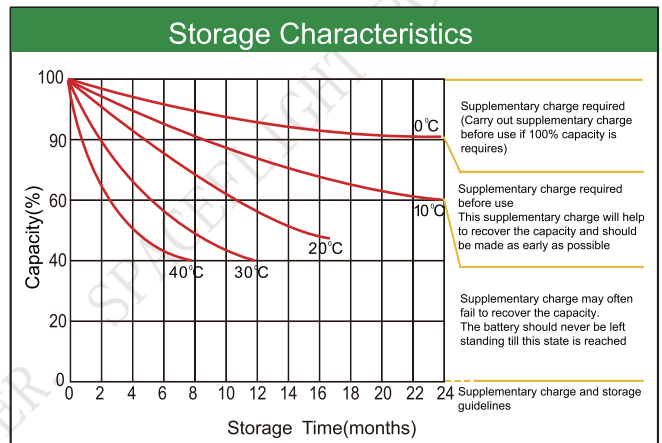
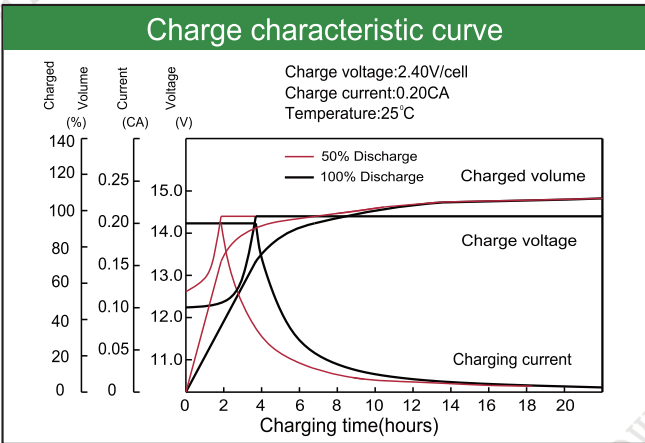
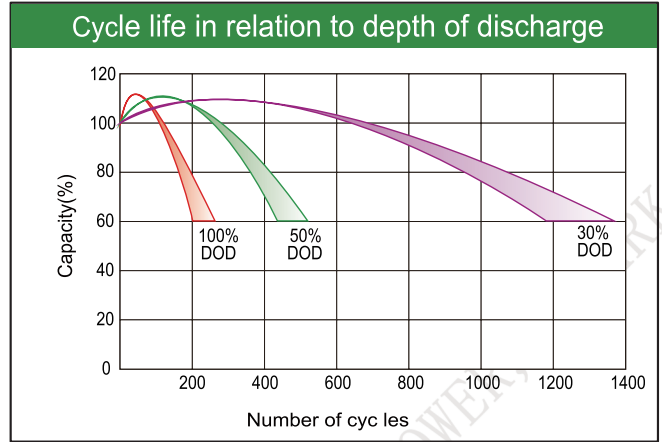
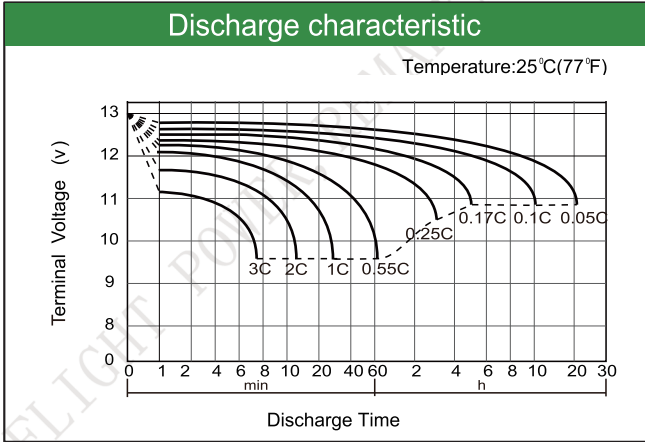

Factory address: Fukang Industrial Zone, Longnan, Ganzhou, Jiangxi Province, China.
 Shenzhen Office: RM208-210, Building D, Tongju industrial Park, No.4, Longping West Road, Longgang District, Shenzhen.
 TEL: +86-755-28288189 sales@sfbattery.com www.sfbattery.com