

### HT Series General Battery

Spaceflight HT Series VRLA batteries are designed with AGM technology, high performance plates and technology to give extra power output for common power backup system. HT series batteries are the general purpose with 5-8 years floating design life at 25°C

### Applications

- Uninterruptible Power Supply (UPS)
- Emergency backup power supply
- Auto control system
- Communication power supply
- Alarm and security system
- Electric Power System (EPS)

### General Features

- 5-8 years design life(25°C)
- Non-spillable construction
- Sealed and maintenance-free
- High reliability and stability
- High purity raw material: long life and low self-discharge

### Standards

- Compliance with IEC, BS, JIS and EU standards.
- UL, CE Certified
- ISO45001,ISO9001 and ISO14001 certified production facilities

### Specifications

Rated Voltage	12V	
Nominal Capacity	28Ah	(C <sub>20</sub> , 10.5V)
Approx Weight	8.6kg±3%(18.96lbs)	
Terminal	F4/F13	
Rated Capacity(25°C)	28.0 Ah	( 20hr,1.4A,10.5V)
	27.0 Ah	(10hr,2.7A,10.5V)
	24.0 Ah	(5hr,4.8A,10.5V)
	20.5 Ah	(1hr,20.5A,9.6V)
Max.Discharge Current	420A(5s)	
Max.Charge Current	7A	
Internal Resistance(25°C)	Approx 11mΩ	
Operating Temp.Range	Discharge	-20~60°C(-4~140°F)
	Charge	-10~50°C(14~122°F)
	Storage	-20~60°C(-4~140°F)
Nominal operating temperature	25±5°C	
Charge Voltage	Cycle Use	Initial Charging Current less than 7A. Voltage 14.4V~15.0V at 25°C(77°F)Temp. Coefficient -30mV/°C
	Standby Use	Initial Charging Current less than 7A. Voltage 13.5V~13.8V at 25°C(77°F)Temp. Coefficient -20mV/°C
Temperature effects on capacity	40°C (104°F)	103%
	25°C (77°F)	100%
	0°C (32°F)	86%
	-15°C (5°F)	65%
Self Discharge(25°C)	Capacity after 3 months storage	91%
	Capacity after 6 months storage	82%
	Capacity after 12 months storage	65%



### Dimensions

unit:mm

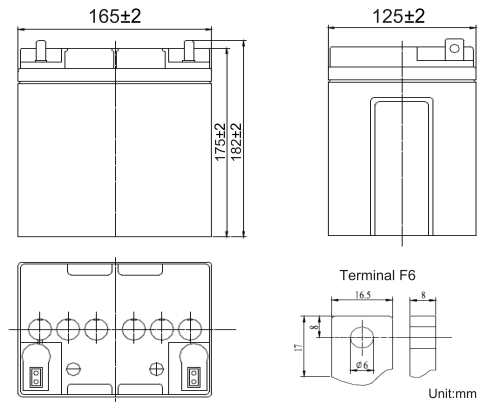

Length	165±2mm (6.50 inches)
Width	125±2mm (4.92 inches)
Container Height	175±2mm (6.89 inches)
Total Height	182±2mm (7.17 inches)

### Battery Construction

Component	Positive plate	Negative plate	Container	Safety valve	Terminal	Separator	Electrolyte
Raw material	Lead dioxide	Lead	ABS(UL94-HB) or FR(UL94-V0)	Rubber	Copper	Fiberglass	Sulfuric acid

### Constant Current Discharge (Amperes) at 25°C(77°F)

E.V/Time	5min	10min	15min	30min	60min	3h	5h	10h	20h
1.60V	115	80.0	58.0	33.0	20.5	8.07	5.28	2.82	1.48
1.65V	109	76.4	55.7	31.8	20.0	7.86	5.11	2.78	1.45
1.70V	103	72.6	53.3	30.5	19.5	7.60	4.94	2.74	1.42
1.75V	97.2	68.7	50.9	29.1	18.9	7.32	4.80	2.70	1.40
1.80V	91.1	64.9	48.4	27.7	18.1	7.02	4.63	2.65	1.38

### Constant Power Discharge (Watts/cell) at 25°C(77°F)

E.V/Time	5min	10min	15min	30min	45min	60min	2h	3h	5h
1.60V	210	140	110	64.7	47.7	37.7	24.0	16.0	10.4
1.65V	197	134	105	61.6	45.5	36.1	23.3	15.6	10.2
1.70V	185	128	99.6	58.4	43.3	34.5	22.5	15.2	10.0
1.75V	172	121	92.8	55.2	41.0	32.8	21.6	14.4	9.9
1.80V	159	113	86	52.0	38.7	31.1	20.7	13.8	9.8

Note: The above characteristics data are average values obtained Within three charge/discharge cycles not the minimum.

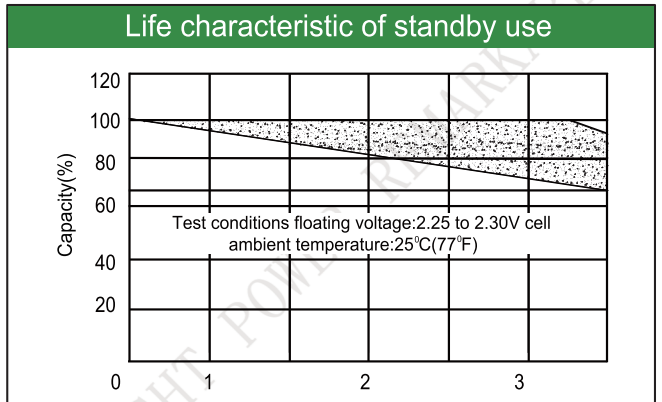
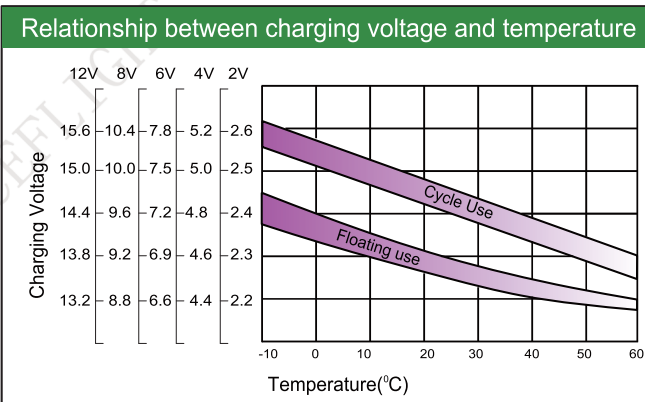
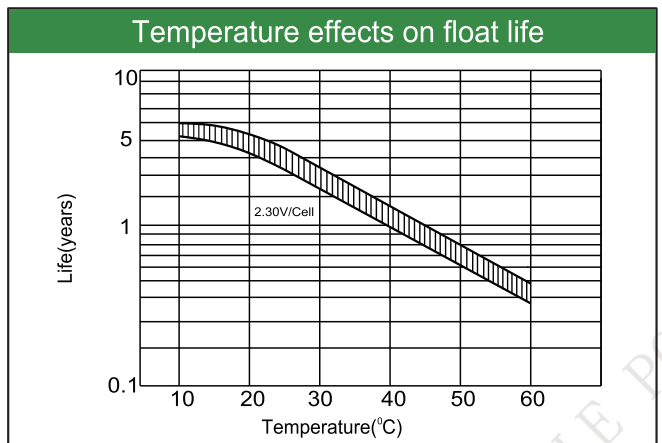
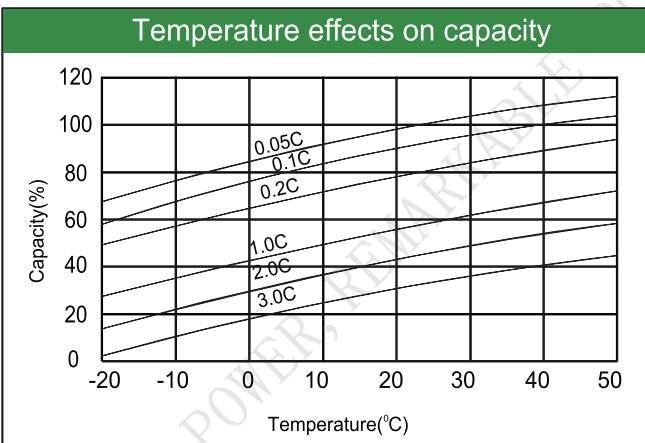
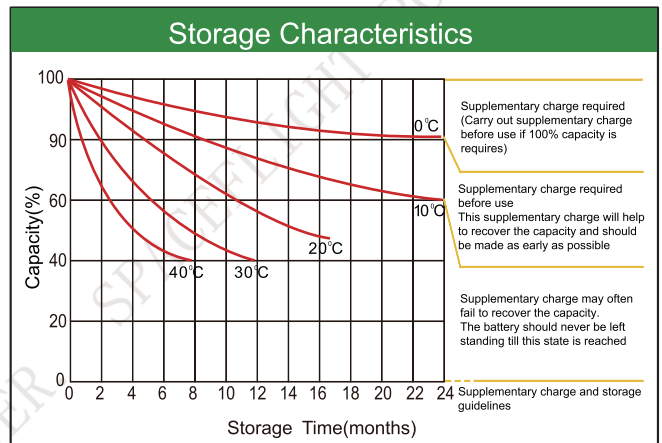
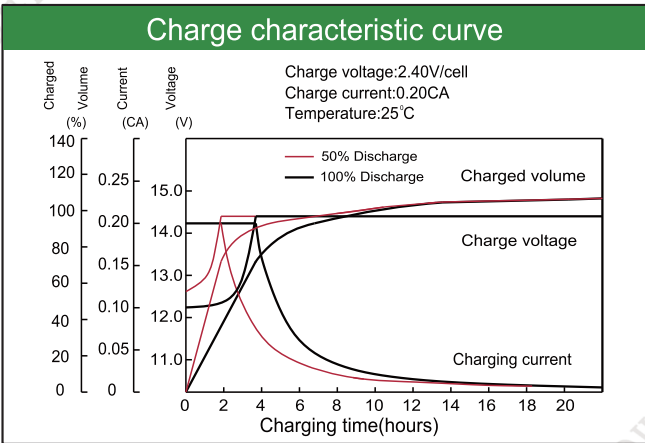
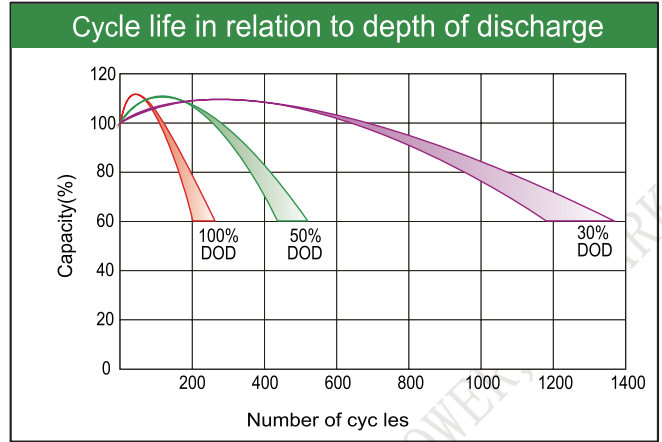
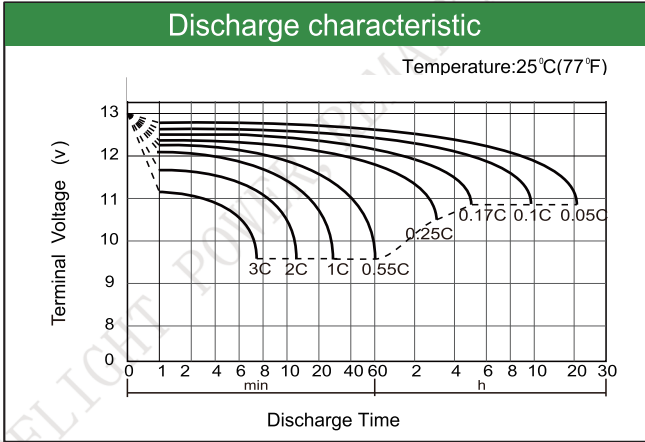

Factory address: Fukang Industrial Zone, Longnan, Ganzhou, Jiangxi Province, China.  
Shenzhen Office: RM208-210, Building D, Tongju industrial Park, No.4, Longping West Road, Longgang District, Shenzhen.  
TEL: +86-755-28288189 [sales@sfbattery.com](mailto:sales@sfbattery.com) [www.sfbattery.com](http://www.sfbattery.com)