

HTG Series Battery

SPACEFLIGHT HTG Series Battery is hybrid GEL battery designed with deep cycle technology to give extra-durable cycle performance. HTG series battery with 20 years floating design life at 25°C.

Applications

- Solar and wind power systems
- Communication systems
- Uninterruptible power supplies
- Golf carts and buggies
- Alarm and security system
- Electric toy and wheelchairs, etc

General Features

- 20 years designed floating life(25 °C)
- Non-spillable construction
- Sealed and maintenance-free
- Excellent recovery from deep discharge
- High density active materials plates
- Longer Life and low self-discharge

Standards

- Compliance with IEC, BS, JIS and EU standards.
- UL, CE Certified
- ISO45001,ISO9001 and ISO14001 certified production facilities

Specifications

Rated Voltage	2V	
Nominal Capacity	500Ah	(C ₁₀ , 1.8V)
Approx Weight	31kg±3%(68.34lbs)	
Terminal	F10	
Rated Capacity(25°C)	500 Ah	(10hr,50A,1.80V)
	440 Ah	(5hr,88A,1.75V)
	378 Ah	(3hr,126A,1.70V)
	300 Ah	(1hr,300A,1.60V)
Max.Discharge Current	2500A(5s)	
Max.Charge Current	125A	
Internal Resistance(25°C)	Approx 0.7mΩ	
Operating Temp.Range	Discharge	-20~60 °C(-4~140 °F)
	Charge	-10~50 °C(14~122 °F)
	Storage	-20~60 °C(-4~140 °F)
Nominal operating temperature	25±5 °C	
Charge Voltage	Cycle Use	Initial Charging Current less than 125A. Voltage 2.4V~2.5V at 25°C(77°F)Temp. Coefficient -30mV/°C
	Standby Use	Initial Charging Current less than 125A. Voltage 2.25V~2.3V at 25°C(77°F)Temp. Coefficient -20mV/°C
Temperature effects on capacity	40 °C (104 °F)	103%
	25 °C (77 °F)	100%
	0 °C (32 °F)	86%
	-15 °C (5 °F)	65%
Self Discharge(25°C)	Capacity after 3 months storage	91%
	Capacity after 6 months storage	82%
	Capacity after 12 months storage	65%



Dimensions

unit:mm

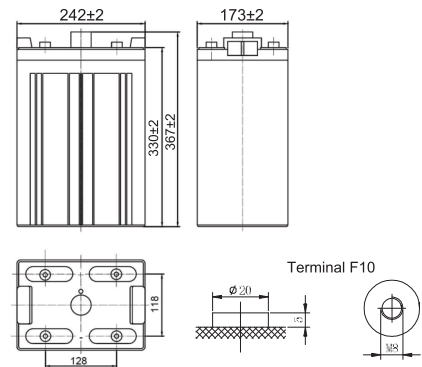

Length	242±2mm (9.53 inches)
Width	173±2mm (6.81 inches)
Container Height	330±2mm (13.0 inches)
Total Height	367±2mm (14.4 inches)

Battery Construction

Component	Positive plate	Negative plate	Container	Safety valve	Terminal	Separator	Electrolyte
Raw material	Lead dioxide	Lead	ABS(UL94-HB) or FR(UL94-V0)	Rubber	Copper	AGM	SiO ₂ +H ₂ SO ₄

Constant Current Discharge (Amperes) at 25°C(77°F)

E.V/Time	5min	10min	15min	30min	45min	1h	3h	5h	10h
1.60V	/	958	736	500	383	300	134	94.5	53.8
1.65V	/	911	703	480	368	290	130	92.5	53.1
1.70V	/	864	675	460	352	278	126	90.5	52.2
1.75V	/	818	643	432	335	266	122	88.0	51.2
1.80V	/	768	611	405	317	253	115	85.0	50.0

Constant Power Discharge (Watts/cell) at 25°C(77°F)

E.V/Time	5min	10min	15min	30min	45min	1h	2h	3h	5h
1.60V	/	1675	1322	930	670	557	378	270	167
1.65V	/	1597	1272	883	645	528	361	260	164
1.70V	/	1518	1222	836	615	502	345	247	161
1.75V	/	1439	1172	787	595	489	330	236	157
1.80V	/	1390	1114	738	586	469	304	217	149

Note: The above characteristics data are average values obtained Within three charge/discharge cycles not the minimum.

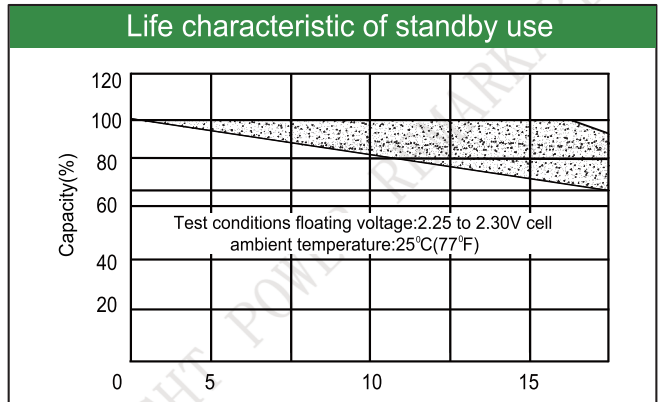
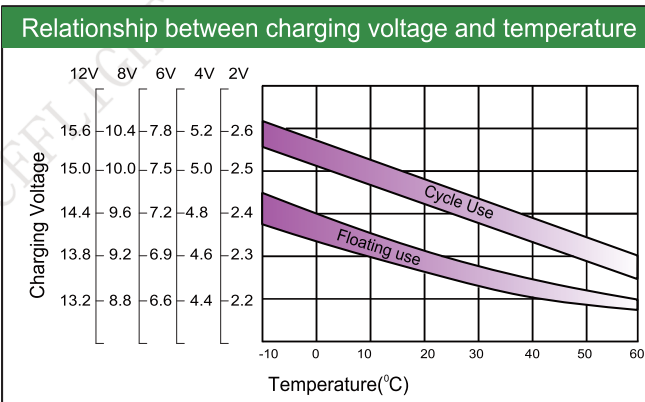
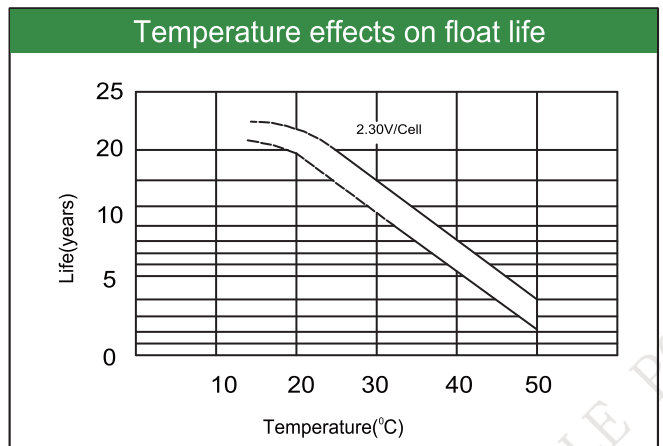
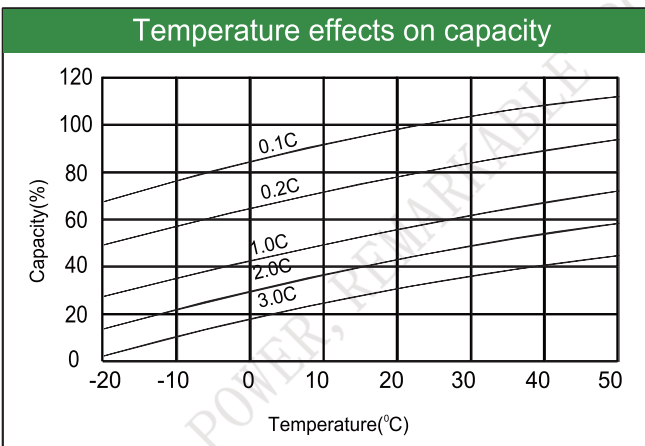
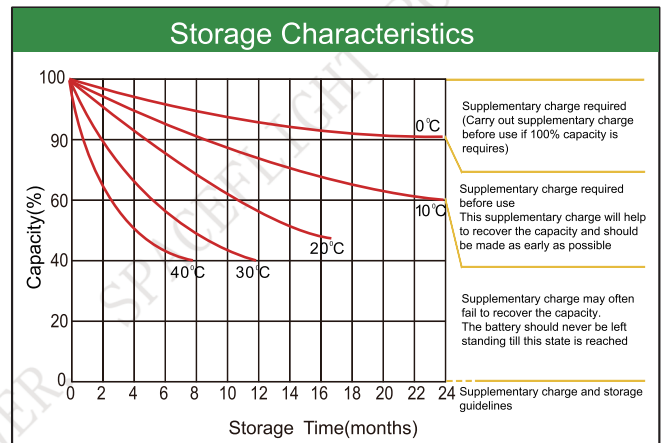
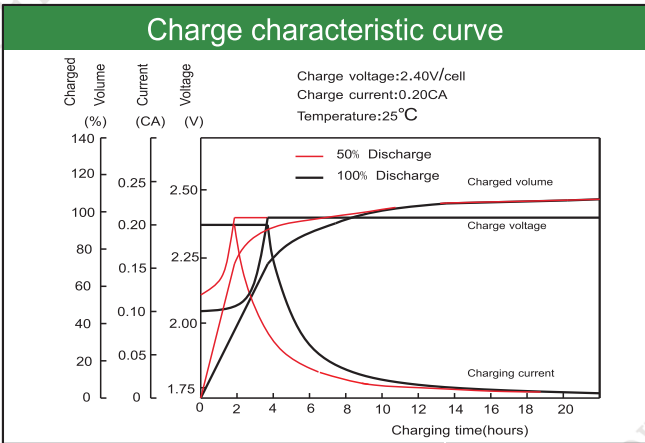
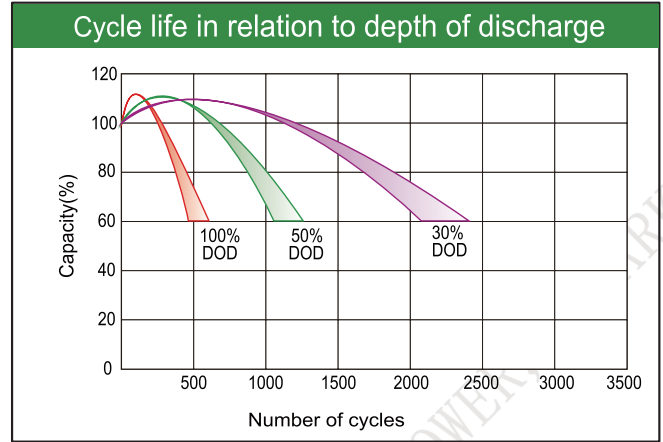
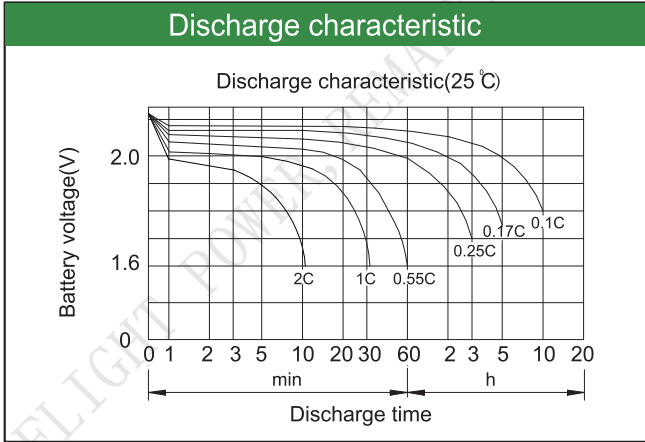

Factory address: Fukang Industrial Zone, Longnan, Ganzhou, Jiangxi Province, China.
 Shenzhen Office: RM208-210, Building D, Tongju industrial Park, No.4, Longping West Road, Longgang District, Shenzhen.
 TEL: +86-755-28288189 sales@sfbattery.com www.sfbattery.com